

MITEL

**SX-200** | Integrated  
Communications Platform

USER GUIDE - SUPERCONSOLE 1000®

 **MITEL** | it's about **YOU**

## NOTICE

The information contained in this document is believed to be accurate in all respects but is not warranted by Mitel Networks™ Corporation (MITEL®). The information is subject to change without notice and should not be construed in any way as a commitment by Mitel or any of its affiliates or subsidiaries. Mitel and its affiliates and subsidiaries assume no responsibility for any errors or omissions in this document. Revisions of this document or new editions of it may be issued to incorporate such changes.

No part of this document can be reproduced or transmitted in any form or by any means - electronic or mechanical - for any purpose without written permission from Mitel Networks Corporation.

Mitel Networks is a trademark of Mitel Networks Corporation.

Other product names mentioned in this document may be trademarks of their respective companies and are hereby acknowledged.

## NOTICE TO CANADIAN CUSTOMERS

This Class A digital apparatus complies with Canadian ICES-003.

## NOTICE TO U.S. CUSTOMERS

This equipment has been tested and found to comply with the limits for a Class A digital device, pursuant to Part 15 of the FCC Rules. These limits are designed to provide reasonable protection against harmful interference when the equipment is operated in a commercial environment. This equipment generates, uses, and can radiate radio frequency energy and, if not installed and used in accordance with the instruction manual, may cause harmful interference to radio communications. Operation of this equipment in a residential area is likely to cause harmful interference in which case the user will be required to correct the interference at his own expense.

**Note:** Changes or modifications not expressly approved by Mitel Networks™ Corporation may void the user's right to operate the equipment.

## NOTICE TO CUSTOMERS IN EU COUNTRIES

The CE mark on this product indicates that this product is in compliance with the 89/336/EEC EMC directive, Class B emissions. As a result it is only intended for use in a commercial or light industrial environment as defined in EN5022. This product complies with 73/23/EEC Low Voltage Directive.

50004006, Rev. B

October 2004

®, ™ Trademark of MITEL Networks Corporation.

© Copyright 2004, MITEL Networks Corporation

All rights reserved.

# Table of Contents

## Chapter 1: Getting Started

Introduction .....	9
About the Console .....	9
Before you begin .....	9
Console Components .....	10
Using this Guide .....	14
Adjusting the Console .....	15
Selecting the Ringing Output .....	15
Turning the New Call Ring Off/On .....	15
Adjusting the Ringer Volume .....	16
Adjusting the Handset and Headset Receiver Volume .....	16
Turning the Console Bell (Ringer) Off/On .....	16
Switching to Night/Day Service .....	16
Setting the Console Language .....	17
Attendant Console Lockout .....	17
Programming Macros .....	18
Special Function Softkeys .....	20
Programming a Macro for Transfer-to-Voice-mail .....	21
Programming a Macro for Last Call Recovery .....	21
Using a SUPERSET™ PKM48 with the Console .....	22
Powering the Console .....	22

## Chapter 2: Call Handling

Answering Calls .....	25
New Call Indication .....	26
When Multiple Calls are Waiting .....	26
Extending (Transferring) Calls .....	26
Misdialed Numbers .....	27
Reaching a Busy Destination or an Extension with Do Not Disturb Activated .....	27
Reaching an Extension with an Advisory Message .....	28
Placing Calls .....	28
Placing a Call on Hold .....	28
Hold Recall .....	29
Hold Pickup .....	29
Stacked Hold .....	30
Setting up Conferences and Call Splitting .....	30
Answering Recalls .....	31
Answering Intercepts to the Console .....	32
Paging from the Console .....	32
PA Paging .....	32

- Extension Paging .....33
- Park and Paging .....34
- Placing Ringing or Paging Intercom Calls .....34
- Setting and Canceling Do Not Disturb on an Extension .....35
- Setting and Canceling Message Waiting on an Extension .....35
- Overriding Busy or Do Not Disturb .....36
- Redialing the Last Number .....36
- Setting up a Serial Call .....37
- Using Tone Signaling .....37
- Flashing on Trunks .....38
- Answering a Call with Night Service Enabled .....38
- Using Directed Call Pickup .....38
- Parking Calls .....39
  - Call Park - System .....39
  - Call Park - Specific Orbit .....39
  - Last Call Retrieve .....40
- Call Logging .....40
- Multiple Console Operation .....41
- Centralized Attendant Service (CAS) .....42
- Voice mail .....42
- Door Opener .....42

**Chapter 3: Using System Functions**

- Viewing System Alarm Information .....45
- Viewing 911 Call Alarms .....46
- Setting System Date and Time .....47
- Canceling All Call Forwarding .....48
- Canceling All Callbacks .....48
- Changing DISA codes .....48
- Setting up System-Abbreviated Dialing Numbers .....49
- Setting up Night Answer Points .....50
- Displaying the System Identification .....50
- Displaying the Console Identity .....51
- Accessing Applications .....51

**Chapter 4: Using Extension Functions**

- Setting/Canceling Call Forwarding .....55
- Setting/Canceling Do Not Disturb .....56
- Setting/Clearing Message Waiting .....56
- Setting/Clearing Advisory Messages .....58
- Taking an Extension Out of Service .....59
- Call Monitoring .....60

**Chapter 5: Using Trunk Functions**

Viewing Trunk Status .....	65
Viewing Trunk Group Busy Status .....	65
Accessing Specific Trunks .....	66
Taking a Trunk Out of Service .....	67

**Chapter 6: Hotel/Motel Features**

Displaying and Changing Room Data .....	71
Listing/Counting Rooms by Occupancy and Condition Status .....	72
Changing Room Occupancy and Condition Status .....	73
Setting/Canceling Wake-up Calls .....	74
Setting Room Call Restrictions .....	75
Blocking Room-to-Room Calls .....	76
Displaying/Clearing a Message Register .....	76
Printing Reports .....	77

**Chapter 7: Reference**

Telephone Directory .....	81
Abbreviated Dialing List .....	82
Class of Service/Restriction .....	83
Console Display Abbreviations .....	84
Advisory Messages for Display Telephones .....	85
Glossary .....	86
Tone Demonstration .....	88
Trunk Identification .....	90



---

# Chapter 1

# Getting Started





## Introduction

---

Take a few minutes to explore this guide – it contains all the information you need to operate the SUPERCONSOLE 1000® Attendant Console.

The first section introduces you to the console. You will learn what each group of keys does and how to interpret information on the console display. This section also contains information about how to use this guide.

### ***A note about feature availability***

The features available on your telephone system have been selected by your company and may not include all the features described in this guide.

## About the Console

---

### Before you begin

Before operating the console, check that the display shows [F1> through [F0> and the correct time and date. Also, make sure the handset is plugged into the side of the console.

If any problems occur, contact your communications department for assistance.

## Console Components

The illustration below shows the main parts of the console. Note the two jacks on the left side. One is for the handset or headset that you use; the other is for the handset or headset used by the person training or monitoring new attendants.

The cabling required to connect the console to the telephone system is located at the rear of the console. The cables should be connected by a qualified system installer and should not be adjusted by unauthorized personnel.

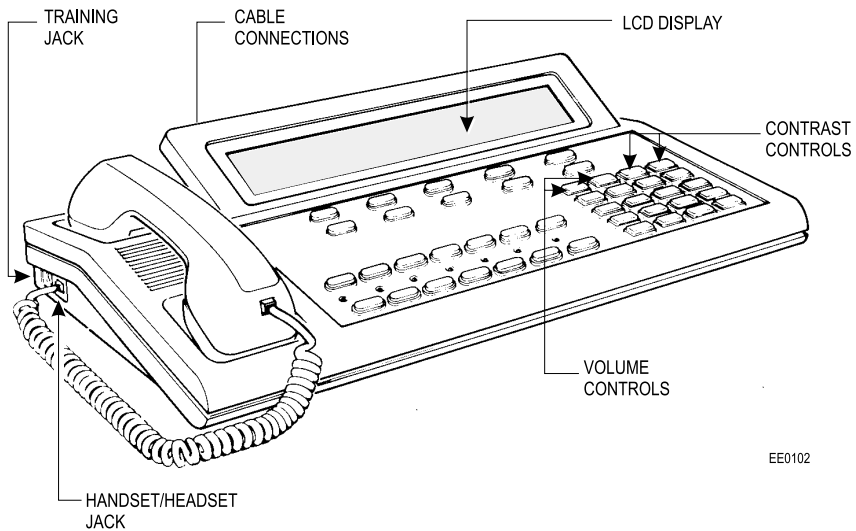

EE0102

## Console Keys

The console has three types of keys: Dialpad keys, Softkeys and Fixed Keys.

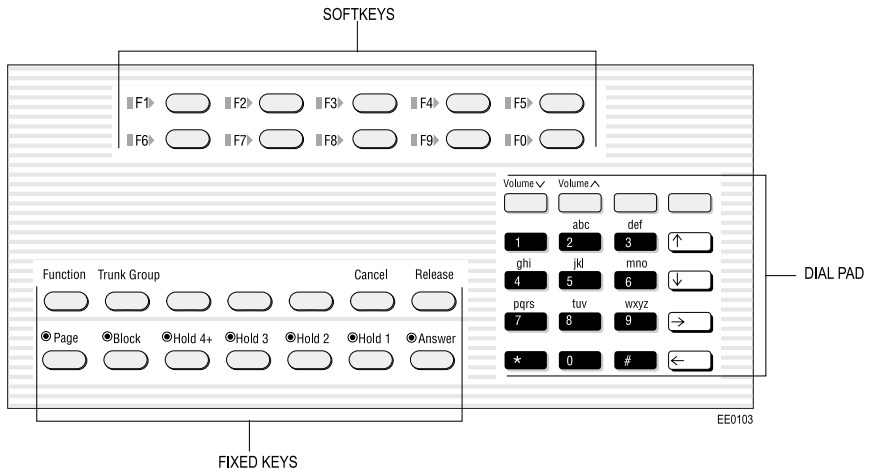

### Dialpad keys

The dialpad on the right side of the console has 20 keys, including the standard 12 dialing keys.

**Ringer Volume keys:** The **Volume** ^ and **Volume** ∨ keys increase or decrease the loudness of the console ringer.



**Note:** The two unlabeled keys next to the Volume keys are reserved for future system enhancements. The unlabeled key next to the Volume keys are reserved for future system enhancements.

**Cursor Control keys:** The ←, →, ↑ and ↓ keys are used in the following circumstances:

**← (Backspace):** Press this key to correct mistakes when dialing extension or trunk numbers or when entering **Function** key information.

The other cursor control keys are used along with the ← key for applications such as Hotel/Motel guest service and Customer Data Entry.

### Fixed Keys

The Fixed keys are arranged in two rows of seven keys. You use them to perform basic operations such as answering calls and placing calls on hold.

Each key in the bottom row has a lamp that indicates the status of a call or feature. For example, when you use a Hold key to place a call on hold, the lamp above the key lights.

Use this key...	When you want to...
Function	activate softkeys (explained in the next section), which are used for operations such as setting the console date and time and switching the console to Night Service.
Trunk Group	see which trunk groups are busy.
Phonebook	dial by name.
Cancel	clear misdialed information.
Set Page	page extension users using their telephone speakers.
Release	disconnect or transfer calls.
Page	make an announcement over the paging system.
Block	restrict selected extensions/guest rooms from calling each other.
Hold	place calls to the console on hold. Hold 1 through 3 are direct holds. Pressing Hold 1, Hold 2, or Hold 3 places a call on hold at that location. Pressing Hold 4+ accesses five additional hold slots.
Answer	answer incoming calls to the console on a “first-come, first-served” basis.



**Note:** The unlabeled key next to the Trunk Group key is reserved for future system enhancements.

## **Softkeys**

Softkeys have functions that change depending on the state of the call you are handling or the feature you are using. For example, when you call a busy extension the display will show the softkey functions that are available for handling the call. One of these functions is Override, another is Msg Waiting.

The [F1> to [F0> labels on the display correspond to the [F1> to [F0> keys on the consoles. To use a softkey function, press the [F1> to [F0> key that corresponds to the display label for that function.

## **Console Display**

During call handling, the upper two lines identify the SOURCE or calling party and the DESTINATION or called party.

The two lower lines, labeled [F1> to [F0>, show the current softkey labels. For example, if [F8> is labeled [Override], pressing [F8> lets you override a busy extension's conversation. At another time, the same key, [F8>, could be labeled [Night 1]. Now, pressing [F8> places the console in Night 1 operation.

## Using this Guide

Some of the procedures in this guide include an illustration of the console display. The illustration shows how the display will look when you are performing the procedure.

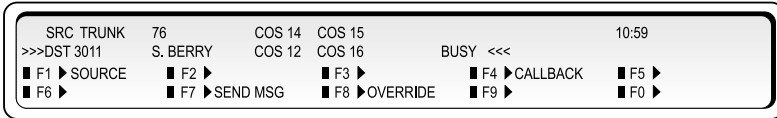

Note the abbreviations in the upper half of the display. The following table explains the meaning of those abbreviations. For explanations of the other abbreviations, including those used in the lower half of the display, see page 84.

Abbreviation	Definition
DST	The DESTINATION (called) party
SRC	The SOURCE (calling) party
>>> <<<	Appears on either the SRC or DST line to indicate which party is currently connected to the console
COS	Shows the Class of Service assigned to the extension or trunk that is currently connected to the console
COR	Shows the Class of Restriction assigned to the extension or trunk that is currently connected to the console
C/W	Preceded by a number to indicate how many calls are waiting to be answered

## Conventions

This guide uses the following conventions to differentiate between the two types of console keys:

- Fixed keys appear in bold letters—for example, **Answer** or **Hold**.
- Softkeys appear in bold letters within brackets—for example, **[BELL ON]** or **[CONF]**.

## Adjusting the Console

---

### Selecting the Ringing Output

You can route the ringing that accompanies an incoming call to the handset/headset instead of the console speaker.

#### *To select the ringing output:*

1. Press **Cancel** while holding down the **Function** key.
2. Press the **[F3>** softkey to toggle the output.
3. Press the **[F2>** softkey to save the change and exit the menu.



**Note:** Emergency 911 calls always ring through the console speaker, regardless of the Ringing Output setting.

### Turning the New Call Ring Off/On

The New Call Ring is a single burst of ringing that can signal the arrival of a second call while the first call is in progress. If the New Call Ring is off, the only way to know that calls are waiting is by the **C/W** indicator on the console display.

#### *To turn the New Call Ring off/on:*

1. Press **Cancel** while holding down the **Function** key.
2. Press the **[F4>** softkey to turn New Call Ring off or on.
3. Press the **[F2>** softkey to save the change and exit the menu.



#### **Notes:**

1. With the ringing output routed to the handset/headset, the New Call Ring will momentarily interrupt the voice of the first caller.
2. Emergency 911 calls always ring regardless of the New Call Ring setting.

## Adjusting the Ringer Volume

**To raise or lower the ringer volume while the console is ringing:**

1. Press and release the **Volume**  $\wedge$  key to increase or the **Volume**  $\vee$  key to decrease the volume.
2. Repeat until the ringing is at the volume you want.

## Adjusting the Handset and Headset Receiver Volume

The Volume keys adjust the volume of the console ringer and the volume of the handset and headset receiver. Although you can have a handset and a headset connected to the console at the same time, the receiver volume for each is not individually adjustable; any volume adjustments you make affect both the handset and the headset.

**To adjust the handset and headset receiver volume while a call is in progress and the console is not ringing, or while the console is idle:**

- Press  $\wedge$  repeatedly to increase the volume or  $\vee$  to decrease it.



**Warning:** Because continuous exposure to loud sounds can contribute to hearing loss, keep the volume at a moderate level.

## Turning the Console Bell (Ringer) Off/On

When the bell is off, a flashing **Answer** key and the **C/W** indicator on the display are the only indications that calls are waiting to be answered.

**To turn the bell on or off:**

1. Press **Function**.
2. Press **[BELL OFF]** or **[BELL ON]**.

## Switching to Night/Day Service

Incoming calls that normally ring the console during the day can ring another answering point at night. Your system may have one or two night service modes called Night 1 and Night 2. The mode you should select depends on system programming.



Any attendant can switch the system into night or day service. When the system is in night service, the night status indicator (Night 1 or Night 2) displays on all consoles.

***To switch to night or day service:***

1. Press **Function**.
2. Press **[NIGHT 1]**, **[NIGHT 2]**, or **[DAY]** as required.

You can change the Night1 and Night2 answering points for individual trunks from the console. For more information, see page 50.

## Setting the Console Language

The console can display call-handling information and softkey prompts in English, French or Spanish. (Other languages may be available depending on system programming.)

***To change languages:***

1. Press **Function**.
2. Press **[LANGUAGE]**.
3. Press the softkey that corresponds to the language you want.

## Attendant Console Lockout

You can enter an access code to restrict the capabilities of the attendant console. This prevents system tampering via the console when you leave it unattended—for example, during breaks. When the console is locked out, it cannot be used to place outgoing trunk calls or to access console functions, except 911 Call alarms. You can still use the console to place internal calls and to answer incoming trunk calls.

***To lock out the console (cannot have calls connected):***

- Enter the console Lockout access code. (Ask your communications department for the code.)

The display shows “Console in Restricted Service.”

***To return the console to normal operation:***

- Re-enter the console Lockout access code.

## Programming Macros

If you frequently perform a console task that requires several keystrokes, you can automate the task using a macro. A macro is a series of keystrokes that you assign to a single key. Instead of repeating the keystrokes each time you want to perform a task, you can press the macro key to execute all the keystrokes at once.

Macros are designed to facilitate the transfer of calls to voice mail or for recovering calls released to the wrong extension. You can also use macro keys for one-button dialing of frequently called telephone numbers; programming macros for other uses is not recommended.

The two unlabelled keys on the console (circled in the illustration below) is available for programming as a macro keys. You can also reprogram the **Trunk Group** and **Set Page** keys and use them as macro keys instead.

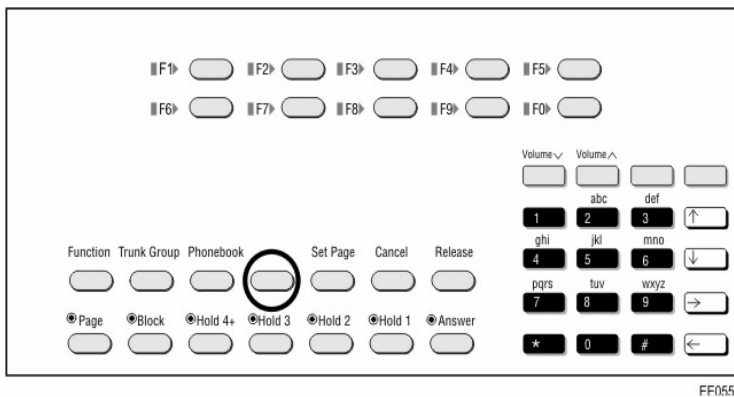

### ***To program a macro or to clear a previously programmed macro:***

1. While holding down the **Function** key, press the softkey that corresponds to the firmkey you want to program.

The display shows the macro keystrokes (if any) currently programmed to the selected key.

FIRM KEY 1: [TONES ON] 7224609

ENTER NEW STRING:

■ F1 ▶EXIT      ■ F2 ▶SAVE/EXIT      ■ F3 ▶[DEST]      ■ F4 ▶[LAST NUM]      ■ F5 ▶[TONES ON]  
 ■ F6 ▶INSERT PAUSE      ■ F7 ▶TRUNK FLASH      ■ F8 ▶[RELEASE]      ■ F9 ▶      ■ F0 ▶CLEAR

EE0502

2. Enter the keystrokes you want to include in your macro.

You can enter up to 15 keystrokes using the dial pad keys and the special function softkeys explained below.

Use the ← key to correct any mistakes.



**Tip:** Write down the keystrokes in case you experience problems with the console and have to reprogram your macros.

3. To clear a previously programmed macro, press the **[CLEAR]** softkey.
4. Clearing macros from keys formerly programmed as **Trunk Group** or **Set Page** keys restores their original function.
5. Press the **[SAVE/EXIT]** softkey to complete the programming.
6. Select another firmkey to program or press the **[EXIT]** softkey to leave programming mode.

**To execute a macro:**

- Press the key programmed with the macro you want to execute.

## Special Function Softkeys

The following special function softkeys are available for programming macros:

Press	To
<b>[DEST]</b>	Dial the number displayed on the DST line when the macro key is pressed. (Used to program a macro to transfer calls to voice mail; see the next section for details.)
<b>[LAST NUM]</b>	Redial the last number dialed from the console when the macro key is pressed. (Used to program a macro to recover the most recently released call; see the next section for details.)
<b>[TONES ON]</b>	Send subsequent digits as DTMF tones. (Required when programming a macro to transfer calls to voice mail; see the next section for details.)
<b>[INSERT PAUSE]</b>	Inserts a 1.5 second pause. When the pause ends, digits after the pause are dialed. You can create a longer pause by pressing the <b>[INSERT PAUSE]</b> softkey multiple times.
<b>[TRUNK FLASH]</b>	Inserts a flash for further dialing on a trunk. For more information, see “Flashing on Trunks” in the SUPERCONSOLE 1000 User Guide.
<b>[RELEASE]</b>	Disconnects the console from the call in progress. (Required when programming a macro to transfer calls to voice mail; see the next section for details.)

## Programming a Macro for Transfer-to-Voice-mail

### *To program a macro that transfers calls to a voice mailbox:*

At step 4 in the programming procedure:

- Dial the voice mail hunt group number.
- Press the **[INSERT PAUSE]** softkey to allow the voice mail system time to respond.
- Press the **[TONES ON]** softkey.
- Press \* or other key (if any) as required by the voice mail system.
- Press the **[DEST]** softkey to dial the digits displayed on the DST line when you press the macro key.
- Press the **[RELEASE]** softkey to complete the transfer and release the console from the call.
- Select another firmkey to program or press the **[EXIT]** softkey to leave programming mode.

Now, when a call you transferred to an unanswered extension recalls, you can press the macro key to transfer the caller to the extension's voice mailbox.

## Programming a Macro for Last Call Recovery

You can program a macro key to recover a call you transferred to the wrong extension. To successfully recover the call, you must press the macro key while the extension is still ringing. Also, you cannot have started another action, such as dialing or answering a call, following the transfer.



**Note:** The Cancel key can also be used to recover calls on systems with LIGHTWARE™ 17, Release 4 software.

### *To program a macro that recovers calls that you transferred to the wrong extension:*

At step 4 in the programming procedure:

- Enter the Directed Call Pickup access code.
- Press the **[LAST NUM]** softkey.
- Press the **[SAVE/EXIT]** softkey to complete the programming.
- Select another firmkey to program or press the **[EXIT]** softkey to leave programming mode.

## Using a SUPERSET™ PKM48 with the Console

Up to two SUPERSET PKM48 modules can be connected to the console. The keys on the modules are programmed by your system administrator as Direct Station Select (DSS)/Busy Lamp Field (BLF) keys. Each key has a lamp that indicates the status of the associated line or extension.

When line/extension is:	the indicator is:
Idle	Off
Busy	On
Ringing	Slow Flash
On Hold	Fast Flash



**Note:** Using a PKM48 module with the console requires LIGHTWARE™ 18, Release 1 software. The console supports the connection of either PKM48 modules or a printer; if both are connected only one will function.

## Powering the Console

The console features a back-lit LCD display for better viewing under a wide range of lighting conditions. Power for the display is supplied by an AC adapter (included with the console). The adapter also powers the console printer port and the optional PKM48 modules.



Use only the supplied AC adapter (Part Number 700063020) to power the console.

---

## Chapter 2

# Call Handling





## Answering Calls

Ringing and a flashing **Answer** key indicate the arrival of a call. The number next to **C/W** in the display indicates how many calls are waiting to be answered.

The information displayed next to the softkeys F1 to F0 indicate the actions you can take by pressing the corresponding softkey.

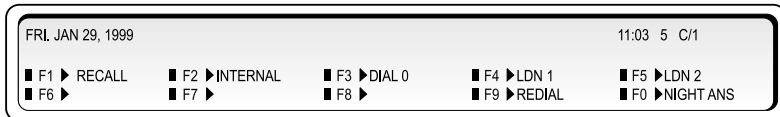

For example, you can answer an outside (trunk) call by pressing **[LDN 1]** (Listed Directory Number 1), or an internal (extension) call by pressing **[DIAL 0]**.

The following softkey prompts can accompany an incoming call:

- **[RECALL]**
- **[INTERNAL]**
- **[DIAL 0]**
- **[PRIORITY 0]**
- **[NIGHT ANS]**
- **[LDN 1], [LDN 2], ... [LDN 9]**
- or any pre-programmed customer-specific information (for example, your company may choose to display [Line 1] instead of [Ldn 1]).

The **[INTERNAL]** softkey indicates calls to a specific attendant made by dialing the console's internal directory number (as opposed to dialing "0"). The other prompts are explained elsewhere in the guide.

**To answer calls:**

Do one of the following:

- Press **Answer** to answer the first call in the queue.
- Press a softkey (F1 – F0) to answer a specific type of call.

The first line of the display shows >>> SRC followed by an extension number and name for an internal call, or a trunk number for an external call. The DST line (the second line) remains blank until you dial a destination number.

## New Call Indication

When you are engaged in a call, a single burst of ringing signals the next incoming call. The ringing is optional; see *Turning the New Call Ring Off/On* on page 15 for more information. Subsequent calls do not ring the console—even with the New Call Ring turned on. The only way to tell that calls are waiting is by the **C/W** indicator on the console display.

The console can be programmed at the system level to provide a single burst of tone at regular intervals when calls are waiting.

## When Multiple Calls are Waiting

You cannot answer a new call until the one you are engaged in is transferred, disconnected, or put on hold.

## Extending (Transferring) Calls

---

When a caller requests to speak to someone, ask the caller to wait a moment, and then transfer the call to the requested destination.

**To extend a call:**

1. Dial the destination number.

The caller is automatically placed on hold while you complete the transfer.

2. When you hear ringing, press **Release** to connect the caller to the destination and release the console from the call.

## Misdialed Numbers

If you do not want to complete dialing, or if you misdial a number, either

- Press  to erase the misdialed digits, and then dial the correct number.
- or -
- Press **Cancel** to return to the Source party, and then redial the number.

## Reaching a Busy Destination or an Extension with Do Not Disturb Activated

If the called destination is busy or the extension has Do Not Disturb activated, the display will show “Busy” or “DND” on the DST line.

In both cases, your options for handling the call are the same, except for the Callback option, which only applies when calling a busy destination.

### ***To handle a call to a busy destination or an extension with Do Not Disturb activated:***

- Press **[SOURCE]** to return to the caller requesting the transfer.
- Press **Cancel** to disconnect the destination so that you can dial a new one.
- Press **Release** to camp the caller on to the busy destination or disconnect the source. (For an explanation of camp-on, see page 86.) If the transfer is not allowed, you will hear a beep tone and “CANT” will show on the display.
- Press **[OVERRIDE]** to break into the busy extension. For more information on using Override, see page 36.
- Press **[SEND MSG]** to send a message waiting indication to the called extension. For more information on Message Waiting, see page 35.
- Press **[CALLBACK]** to receive notification when the destination is free.

If you reach a busy extension or you are placing an outside call and all of the trunks are busy, you can request an automatic Callback. The system monitors the line and rings the console when the line becomes free. When you answer a Callback at the console, the top line of the display will show “CALLBACK.” Callbacks on outside calls are used when all system trunks are busy, not when the called party is busy.

## Reaching an Extension with an Advisory Message

Users with a display phone can show a short message, called an Advisory Message, on other display phones or consoles that call their phone. When you call an extension with an Advisory Message, the message appears on the DST line of the console display as follows:

```
>>>DST 3070 S.BERRY   IN A MEETING RINGING<<<
```

In this example, the user has left the message “In a meeting” on his or her phone. For a list of other Advisory Messages, see page 85. See also *Setting/Clearing Advisory Messages* on page 58.

## Placing Calls

---

### ***To place a call:***

1. Dial the destination number using the dialpad keys.  
The dialed number appears on the second line of the display.
2. After completing the call, press **Release** to disconnect it from the console.

## Placing a Call on Hold

---

You can place up to three calls on hold using the fixed Hold keys. If you need to place more calls on hold, use the Hold 4+ key in combination with the softkeys.

### ***To place a call on hold:***

1. Inform the caller that you are placing the call on hold.
2. Press **Hold 1**, **Hold 2** or **Hold 3**.  
Its lamp lights indicating the call is on hold.

### ***To retrieve a call on hold:***

- Press **Hold** that was used to place the call on hold.

**To access the five Hold slots available on the softkeys:****1. Press Hold 4+.**

The display changes as follows:

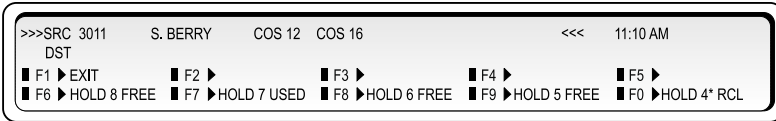

The display shows that Hold slots 5, 6, and 8 are free, Hold 7 is in use, and Hold 4\* is "recalling" the console.

**2. Press a free [HOLD] softkey.**

The lamp above the **Hold 4+** key lights whenever any of the softkey hold slots are in use.

The display returns to the information that was showing before you pressed the **Hold 4+** key.

**To retrieve a call at a softkey Hold slot:****1. Press Hold 4+.****2. Press Hold softkey that was used to place the call on hold.**

## Hold Recall

If a call is left on hold longer than a specified time, it returns to the console as a recall. The lamp above the Hold key used to place the call on hold flashes and the console beeps once to indicate a recall at Hold 1, twice for Hold 2, three times for Hold 3, and four times for calls on hold at any of the softkey Hold slots.

To answer the recall, follow the procedure above for retrieving a call on hold.

## Hold Pickup

Extensions can pick up calls placed on hold at the console by dialing a Hold Pickup code and the Hold slot number. The call and the code required to retrieve it are usually announced using paging. For more information, see page 32.

## Stacked Hold

When an extension has a call on hold, or is in a conference call, and dials the attendant, the display will indicate a held or conferenced call. For example, a held call would show as:

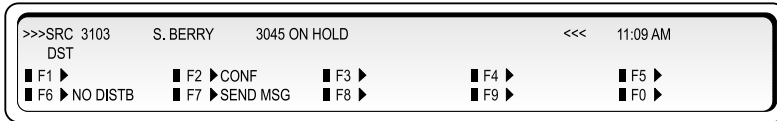

Pressing the **[CONF]** softkey establishes a conference call involving the console and extensions 3103 and 3045.

## Setting up Conferences and Call Splitting

When you are setting up a call between two parties, you may want to conference the call (speak with both parties at the same). Once you establish the conference, you can speak privately to either party by splitting the conference.

### **To conference a call:**

1. Start with a call involving one of the parties you want to include in the conference.
2. Call the other party.
3. Press the **[CONF]** key.

### **To split a conference call:**

- Press **[SOURCE]** to speak privately to the first party or **[DEST]** to speak privately to the other party.

***To release the console from a conference call:***

Do one of the following:

- Press **Release** to connect both parties and then release them from the console.
- Press **Cancel** to release the parties from the console without first connecting them.

## Answering Recalls

---

When a call is transferred and the extension is busy or does not answer, the call either returns to the console within a specified time or is directed to the extension's voice mailbox (if available).

***To answer a “No Answer” recall:***

1. Press **Answer** or **[RECALL]**.
2. Inform the caller that the destination is not answering.
3. Do one of the following:
  - Press **[RING AGAIN]** to redial the same destination.
  - Dial a new destination, and then press **Release**.
  - Press **Cancel** to disconnect the Source party.

***To answer a “Busy” recall:***

1. Press **Answer** or **[RECALL]**.
2. Inform the caller that the destination is busy.
3. Do one of the following:
  - Press **Cancel** to disconnect the Source party.
  - Press **Release** to transfer the call to the same destination again.
  - Press **[DEST]** to reconnect with the busy destination.

4. If you pressed [**DEST**], do one of the following:
- Press [**OVERRIDE**] to break into the busy extension.
  - Press [**SEND MSG**] to send a message waiting indication to the busy extension.
  - Press [**SOURCE**] to connect to the Source party.
  - Press [**CALLBACK**] to receive notification when the extension is free.
  - Press **Release** to camp the source on to the destination again. (See page 86 for an explanation of camp-on.)
  - Press **Cancel** to clear the destination and dial a new extension number.

## Answering Intercepts to the Console

---

Misdialed calls from extensions, or calls to extensions with Do Not Disturb activated, could ring the console depending on system programming.

When you answer the call, the display will show the reason for the interception:

- DND INT for calls to an extension with Do Not Disturb activated.
- ILL # INT for illegal number dialed.
- VAC # INT for vacant (unassigned) number dialed.

## Paging from the Console

---

TwoThree types of paging are available from the console: Public Address (PA) Paging and Extension Paging Public Address (PA) Paging, Extension Paging and Park and Paging.

### PA Paging

If your system has external paging equipment, you can place a call on hold, and then page for someone to pick up the call from the console Hold slots. You can also use PA Paging to make public announcements.

Your paging equipment may be set up to access several areas or “zones.” If so, you use the **Page** key to speak to all zones at once and access codes to speak to individual zones. These codes are available from your communications department.



***To page someone to pick up a call on hold at the console:***

1. Place the Source call on hold. (See page 28.)

2. Press and hold **Page**.

The lamp above the **Page** key lights.

3. Do one of the following:

- If you have only one paging zone, announce the Hold Pickup access code and the Hold slot number appearing on the top line of the display.
- If you have more than one page zone, dial the two-digit paging code (dial 00 for all zones), and then announce the Hold Pickup access code and the Hold slot number.
- If any of the paging zones are busy, the display shows “Busy” on the second line. Press **[OVERRIDE]** to interrupt the page in progress.

4. Release **Page**.

## Extension Paging

Extension Paging allows you to page extension users using their telephone speakers. This feature is available only for paging telephones that are programmed as key system telephones.

You can use Extension Paging to page a specific extension (Directed Page), multiple extensions assigned to a group (Group Page), or all extensions (All Set Page).

***To page an extension:***

1. Press **Set Page**.

2. Do one of the following:

- To page a specific extension, dial the extension number.
- To page a group of extensions, press **[GROUP PAGE]**, and then press the two-digit group number.
- To page all extensions, press **[ALL SET PAGE]**.

3. Make the page.

## Park and Paging

Park and Paging allows the system to assign an orbit number to park a call and page the telephone. Park and Paging options include

- Park and Page Set: After a call is parked, the system performs an All Set Page.
- Park and Page Group: After a call is parked, the system pages the user's Paging Group.
- Park and Page: After a call is parked, the called party must enter the extension or Page Group number.
- Park and PA Page: After a call is parked, the called party must enter a Paging Zone number (0-9).

### ***To park a call and perform a page:***

1. Press **[PARK & PAGE]**.
2. Do one of the following:
  - Enter the extension number to page.
  - Select one of the displayed paging options: All PA Zones, Group Page, All Set Page, PA Zone Num, Group & PA, All Set & PA.
3. For zone paging, enter the two-digit PA Zone number.

## Placing Ringing or Paging Intercom Calls

---

A called party can be either paged or rung when receiving an intercom call.

### ***To place either paging or ringing intercom calls:***

1. Make a call.
2. Press **SET PAGE**.

## Setting and Canceling Do Not Disturb on an Extension

---

Do Not Disturb (DND) prevents calls from ringing a user's extension. You can set and cancel DND on a user's extension while you are on a call with the user.

### *To set or cancel DND on an extension:*

1. While connected to the extension, press **[NO DISTB]**.

"DND" appears next to the extension information on the display to indicate that Do Not Disturb is set.

2. Press **Release**.

You can also set and cancel DND without calling the extension. For more information, see page 56.

## Setting and Canceling Message Waiting on an Extension

---

If an extension is busy or the user does not answer, you can send a notice to let the user know a message is waiting at the console. You can also cancel messages you left at an extension.

### *To set or cancel Message Waiting on a ringing or busy extension:*

1. Press **[SEND MSG]** to set Message Waiting or **[CLEAR MSG]** to clear it.

"MSW" appears next to the extension information on the display to indicate that Message Waiting is set.

2. Press **Release**.

If you are setting Message Waiting on display telephone, an indication appears on the display to let the user know a message is waiting at the console. On other types of telephones, either a flashing lamp or distinctive ringing every 20 minutes indicates that a message is waiting.

## Overriding Busy or Do Not Disturb

---

The Override feature allows you to intrude into a busy extension or an extension with Do Not Disturb (DND) active.

### **To use Override:**

1. Press and hold **[OVERRIDE]**.

If you are overriding a busy extension, both parties hear a long beep, and then you enter the conversation. You will remain connected to the conversation until you release the **[OVERRIDE]** softkey.

If you are overriding an extension with DND active, you will hear ringing.

2. Press **Cancel** or **Release** to disconnect the console from the busy extension.

If the busy extension hangs up while you are pressing **[OVERRIDE]**, you will hear fast busy tone and the display will show “Hung Up” instead of “Busy.”

## Redialing the Last Number

---

You can redial the last manually dialed number (internal or external) by pressing a single key.

### **To redial the last number:**

- Press **[REDIAL]**.

## Setting up a Serial Call

---

The Serial Call feature allows outside callers to talk to more than one extension user in sequence without redialing the main business number each time.

### ***To set up a serial call while connected to an outside call:***

1. Tell the caller to remain on the line after completing each call.
2. Press [**SERIAL CALL**].
3. Dial an extension number.
4. Press **Release**.

When the extension user hangs up, the outside call returns to the console as a recall.

5. When the call returns to the console, press [**RECALL**].
6. Dial the next extension number, and then press **Release**.
7. When all calls are completed, press [**SERIAL CALL**] and then **Release**.

## Using Tone Signaling

---

You may have noticed that when you dial a number at the console, you do not hear any of the tones or pulses normally associated with telephones. This is because the console “communicates” with the rest of the telephone system using a different type of signaling.

However, there are times when telephone equipment, either in or outside your office, needs to receive tones to complete a call. Typically, special services such as Voice mail systems (described on page 42) require information in the form of tones before allowing access.

### ***To enable tone signaling while connected to a service requiring tones:***

1. Press [**TONES ON**].
2. Dial the required code.
3. When you complete the call, press [**TONES OFF**] to turn off tone signaling.

## Flashing on Trunks

---

A trunk flash is a signal sent to another telephone system to do something such as place a call on hold. You may need to use this feature when you have a call from another PABX in your own company network, and you want to transfer it to the originating PABX or to a third one.

You can flash only when you are talking on a trunk to another trunk in a two-party call.

### *To flash on a trunk for further dialing:*

1. Press **[FLASH]**.
2. Dial the required number.
3. Press **Release**.

## Answering a Call with Night Service Enabled

---

When the console is in Night Service, incoming calls ring night bells or some other night answering point. These calls can still be answered from the console even though they do not ring the console bell.

The night answer point is programmed at the system level. If required, you can change the night answering point for individual trunks from the console. For more information, see page 50.

### *To answer a call when the console is in Night Service:*

- Press **[NIGHT BELL]**.

## Using Directed Call Pickup

---

Directed Call Pickup allows you to answer a call ringing at an extension. You can also use this feature to retrieve a call that you transferred to the wrong extension.

### *To pick up a call ringing at an extension:*

1. Dial the Directed Call Pickup code. (Your communications department can provide the code.)
2. Dial the extension number of the ringing extension.
3. Speak to the calling party.

## Parking Calls

---

Two types of call parking are available from the console: Call Park - System and Call Park - Specific Orbit. You can also retrieve a call that was transferred to the wrong extension.

### Call Park - System

Parking a call is the same as placing it on hold except that the call is held by the system, not by the console Hold keys. When you park a call, the system assigns it to a parking orbit and displays the Call Park Retrieve access code and the Park Orbit number. You can then use paging to announce the call and the digits the paged party must dial to retrieve the call.

#### *To park a call:*

- Press **[SYSTEM PARK]**.

#### *To return to the caller if all park orbits are in use:*

- Press **Cancel**.

#### *To retrieve a parked call:*

- Dial the Call Park Retrieve Feature Access Code, and then dial the **Park Orbit Number**.

#### *To re-park the call:*

- Press **[PARK AGAIN]**. The **[PARK AGAIN]** softkey is only available immediately after you answer the call.

### Call Park - Specific Orbit

Call Park - Specific Orbit allows the called party to park a call in a specific orbit by entering a two-digit (01-25) orbit number.

#### *To park a call in a specific orbit:*

1. Press **[SYSTEM PARK]**.
2. Enter a two-digit Orbit Number (01-25).

If the selected orbit already has a parked call, press **Orbit Number** and then enter another orbit number.

## Last Call Retrieve

This feature allows you to recover a call you transferred to the wrong extension. The call must still be ringing the original extension to be recovered.

### *To retrieve the last call transferred from the console:*

- Press **Cancel**.

## Call Logging

---

Call Logging allows extension users with display phones to see who called them and when. As the attendant, you can monitor call log usage and delete logs to make room in the system for new ones. (The system can store a maximum of 2000 logs.) You can also turn off call logging at an extension to conserve log space while the user is away from the office.

### *To view the number of call logs in use in the system:*

1. Press **Function**.
2. Press the **[ATT FNCTION]** softkey.
3. Press the **[CALL LOGS]** softkey.

### *To view and optionally delete an extension user's call logs:*

1. Press **Function**.
2. Press the **[ATT FUNCTION]** softkey.
3. Press the **[SATIIONS]** softkey.
4. Dial the extension number.
5. Press the **[CALL LOGGING]** softkey.
6. (Optional) Press the **[DELETE ALL]** softkey to delete all logs, **[DELETE NEW]** to delete unviewed logs, or **[DELETE OLD]** to delete logs previously viewed.



***To turn off call logging at an extension:***

1. Press **Function**.
2. Press the **[ATT FUNCTION]** softkey.
3. Press the **[STATIONS]** softkey.
4. Dial the extension number.
5. Press the **[CALL LOGGING]** softkey.
6. Press the **[DISABLE LOGS]** softkey.

Only the extension user can turn on call logging from his or her phone.

## Multiple Console Operation

---

When more than one console is in use at the same time, they will operate in one of two ways:

### 1. Independent Operation

Consoles in this arrangement operate independently. Each console has unique hold slots and incoming calls ring a specific console. A recall to the attendant returns only to the console that initially handled the call.

### 2. Transparent Operation

With transparent operation, all consoles operate the same way. Recalls return to all consoles, not just to the console that originally handled the call.

The consoles are also given privileges to read or cancel messages left at an extension by other extension users or the attendant. For more information about reading and canceling messages, see page 57.

## Inter-Console Calls and Transfers

An attendant can make and transfer calls to another attendant by dialing the console's directory number, but not by dialing 0 (zero). Whether you are transferring calls to an extension or another attendant, the procedure is the same—see page 26 for instructions.



**Note:** Inter-console calls cannot be put on hold.

## Centralized Attendant Service (CAS)

---

CAS allows an attendant at one PABX to answer calls that arrive at another interconnected PABX. Except for recalls, CAS has no effect on the way you handle calls from the console. When a call from another PABX in a CAS system recalls the console, it appears as a "Dial 0" call. Keep this in mind when answering the recall as it may affect how you greet the caller.

## Voice mail

---

A voice mail system connected to your telephone system does not affect the operation of the console. If a call is answered by such a system, you may be prompted to enter an access code or an identification number. Before responding to the prompt, you must turn on tone signaling using the **[TONES ON]** softkey. For more information, see *Using Tone Signaling* on page 37.

## Door Opener

---

Door Opener allows an extension user to operate a third-party door opener. When someone requires entry, a designated extension (or extensions) rings, and on answering the extension user can press a feature key or dial a feature access code to open the door.

### ***To operate the door opener:***

Do one of the following:

- Press **[OPEN DOOR]**.
- Dial the Open Door Feature Access code.

---

## Chapter 3

# Using System Functions



## Viewing System Alarm Information

An alarm indicator on the display means a fault in the telephone system has occurred. You can read information about the nature and location of the fault from the console.

### To read an alarm message:

1. Press **Function**.
2. Press **[ALARM]**.

The display shows, for example:

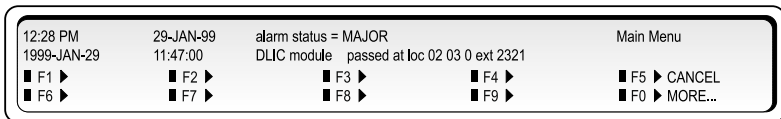

3. Record all the alarm information.
  - Press **[MORE...]** to display additional information or other alarms (if any).
  - The Alarm indicator will continue to flash until all alarm messages have been displayed.
  - Contact your communications department.
4. Press **[EXIT]**.

The system may be programmed to raise an alarm when an extension is left off-hook without a call too long. If so programmed, the console will ring with no calls waiting. To cancel the alarm and stop the ringing, press **Function** followed by **[SHOW LOCKOUT]**, and then press **[CLEAR]**.

## Viewing 911 Call Alarms

This feature raises an alarm at the console when an extension user places a 911 (or other designated Emergency Services number) call and identifies the extension that placed the call. With this information, you can direct emergency services (for example, police or ambulance personnel) to the location from which the call was placed.

When a 911 Call alarm is raised, the console rings and the display shows “911 Call <Press Function Key for Details> ALARM”.



**Note:** Although the console alarm indicates the calling extension's location, the emergency could be somewhere else—for example, in another room or on a different floor. Therefore, it is important to get verbal confirmation from the caller about where help is needed.

### To read a 911 Emergency Call alarm message:

1. Press **Function**.
2. Press **[ALARM]**.
3. Press **[SHOW 911]**.

The display shows:

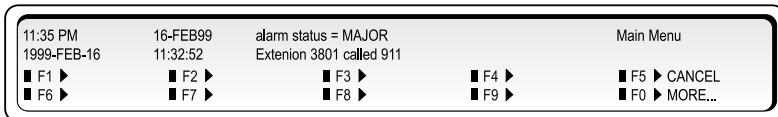

4. Record the number of the extension from which the 911 call originated.

If additional 911 calls were made, press **[MORE]** to view them.

To delete the 911 alarm, press **[CLEAR]**.

5. Contact the appropriate emergency services.
6. Press **[EXIT]**.

If an attendant console is in Attendant Console Lockout state, you can still access 911 alarm information, but you cannot clear the alarms.

## Setting System Date and Time

---

You can change the date and time appearing on the console display. The time displays either in 12- or 24-format depending on system programming.

### *To set the time:*

1. Press **Function**.
2. Press [**ATT FUNCTION**].
3. Press [**SET TIME**].
4. Enter the current time using four digits (hh:mm).

For example, for 9:30 enter 0930.

5. Press [**PM**] if applicable.

[**PM**] appears only if the system is set to 12-hour format, and the hour entered is in the range 01 – 12.

6. Press [**SET**].

[**SET**] appears only if the time has been entered correctly. You can use the  key to make corrections.

7. Press [**EXIT**].

### *To set the date:*

1. Press **Function**.
2. Press [**ATT FUNCTION**].
3. Press [**SET DATE**].
4. Enter the current date in day/month/year format.

For example, for December 12, 1999, enter 121299.

5. Press [**SET**].
6. Press [**EXIT**].

## Canceling All Call Forwarding

---

You can cancel Call Forwarding on all extensions in the system.

### *To cancel Call Forwarding on all extensions:*

1. Press **Function**.
2. Press [**ATT FUNCTION**].
3. Press [**MORE...**].
4. Press [**CAN. ALL FWD**].

You can also set up Call Forwarding for individual extensions from the console. For more information, see page 55.

## Canceling All Callbacks

---

You can cancel Callback messages on all extensions in the system.

### *To cancel Callbacks on all extensions:*

1. Press **Function**.
2. Press [**ATT FUNCTION**].
3. Press [**MORE...**].
4. Press [**CAN. ALL CBK**].

## Changing DISA codes

---

You can change the DISA (Direct Inward System Access) code that outside callers must dial to access system features.

### *To change the DISA access code:*

1. Press **Function**.
2. Press [**ATT FUNCTION**].
3. Press [**MORE...**].
4. Press [**DISA CODE**].
5. Enter the new access code.
6. Do one of the following



- Press **[SET]** to confirm the new access code.
- Press **[EXIT]** to exit without changing the code.

## Setting up System-Abbreviated Dialing Numbers

---

Abbreviated dialing allows extension users to call a telephone number or enter a system access code by dialing a three-digit index number. You can program and display system-abbreviated dialing numbers from the console.

### *To program or display system abbreviated dialing numbers:*

1. Press **Function**.
2. Press **[ATT FUNCTION]**.
3. Press **[ABBR DIAL]**.
4. Enter a three-digit index number from 000 to 999.

Press  to delete entry errors and then enter the correct number.

5. Press **[PRIVATE]** to not display the number when dialed.
6. Press **[ENTER]**.
7. Press **[CANCEL]** to change the existing number.
8. Enter the new number. (Include the outside line access code (e.g. "9") and an area code, if applicable.)

You can insert pauses in the numbers. Enter \*9 for each 1-second pause; enter \*1 for each 5-second pause.

Press  to delete entry errors, and then enter the correct number.

9. Press **[SET]**.
10. Repeat step 4 to 9 to program other numbers, or press **[EXIT]** to end programming.

## Setting up Night Answer Points

---

A night answer point is the number of an extension or other destination where incoming trunk calls will ring when the system is in Night Service. For more information about Night Service, see page 16.

### *To set up night answer points:*

1. Press **Function**.
2. Press [**ATT FUNCTION**].
3. Press [**MORE...**].
4. Press [**FLEX NIGHT**].
5. Enter the trunk number.
6. Press either [**NIGHT 1**] or [**NIGHT 2**] to choose the night service mode.
7. Dial the destination number of the night answer point.

The destination can be an extension, an attendant console directory number, an LDN number on a console, a hunt group or a Night Bell directory number.

8. Press [**SET**] to confirm the new number or [**EXIT**] to exit without making changes.

## Displaying the System Identification

---

A System Identification number may be assigned to your PABX. This number appears on Station Message Detail Reporting (SMDR) and traffic-measurement reports to identify your system when central polling equipment is used. It is usually unnecessary to change this number once it is entered.

### *To display or change the System Identification:*

1. Press **Function**.
2. Press [**ATT FUNCTION**].
3. Press [**SYSTEM IDENT**].
4. Enter a new three-digit number if required.
5. Press [**SET**] to confirm the new number.

## Displaying the Console Identity

---

The console has an extension number which extension users can dial instead of "0" (zero) to call you. You can display the console extension number along with the system software version.

*To display the console extension number and the system software version:*

1. Press **Function**.
2. Press [**IDENTITY**].

## Accessing Applications

---

The Application function is primarily used by maintenance personnel or someone responsible for doing Customer Data Entry (CDE). Access to these functions requires a password.

*To access the Application function:*

1. Press **Function**.
2. Press [**APPLICATION**].

Your Communications Department will give you further instructions if you are required to do any Customer Data Entry.



---

**Chapter 4**  
**Using Extension Functions**



## Setting/Canceling Call Forwarding

---

You can set up and cancel Call Forwarding on individual extensions from the console.

The instructions that follow apply to systems programmed with Split Call Forwarding, which allows you to specify different destinations for internal and external calls. If your system is programmed with another type of Call Forwarding, internal and external calls will both go to the same destination. Note that calls from the console are considered external.

### *To set or cancel Call Forwarding on an extension:*

1. Press **FUNCTION**.
2. Press **[ATT FUNCTION]**.
3. Press **[STATIONS]**.
4. Dial the number of the extension for which you want to set or cancel Call Forwarding.

If you dial an invalid number, press **[CLEAR No.]**.

5. Press **[CALL FWD]**.
6. Do one of the following:
  - Press **[INTERNAL]** to set or cancel call forwarding of internal calls.
  - Press **[EXTERNAL]** to set or cancel call forwarding of external calls.
7. Do one of the following:
  - Press **[CANCEL]** to cancel the current call forwarding.
  - Dial a destination and then select the type of call forwarding—Always, No Answer, etc.

To return to the main display without making changes, press **[EXIT]**.

## Setting/Canceling Do Not Disturb

---

Do Not Disturb (DND) prevents calls from ringing an extension. You can set and cancel DND on any extension in the system.

### *To set or cancel DND on an extension:*

1. Press **Function**.
2. Press [**ATT FUNCTION**].
3. Press [**STATIONS**].
4. Dial the extension number.
5. Press [**No DISTB**].

The first line of the display shows "DND" to indicate that DND is set.

You can also set and cancel DND while on a call to an extension. For more information, see page 36.

## Setting/Clearing Message Waiting

---

You can notify extension users that a message is waiting for them at the console. When the user returns and calls the console, the display shows "MSW" to indicate that there is a message waiting for that extension.

Use this feature if you know that the person you are trying to contact is out of the office. If you know that the person is in the office, use the Callback feature described on page 27.

### *To set or clear Message Waiting on an extension:*

1. Press **Function**.
2. Press [**ATT FUNCTION**].
3. Press [**STATIONS**].
4. Dial the extension number.
5. Do one of the following:
  - Press [**SEND MSG**] to set message waiting.
  - Press [**CLEAR MSG**] to clear message waiting.
6. Press [**EXIT**].



## Reading and Clearing Messages

Depending on your system's programming, you may be able to read and clear messages left for an extension by another user or attendant console. Without this capability, you can only read and clear messages that you have set.

### *To read and cancel an extension's messages:*

1. Press **Function**.
2. Press [**ATT FUNCTION**].
3. Press [**STATIONS**].
4. Dial the extension number.
5. Press [**READ MSG**].

The absence of [**READ MSG**] on the display means that you are not authorized to read or clear messages other than those you have left.

The display shows the number of messages at that extension, the extension number of the user that left the message, and when the message was left.

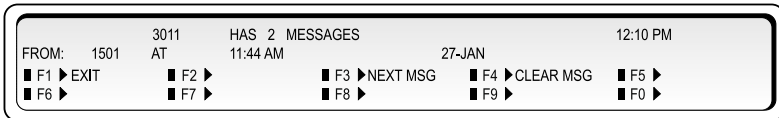

6. Do one of the following:
  - Press [**NEXT MSG**] to read the extension's next message.
  - Press [**CLEAR MSG**] to clear the message.
  - Press [**EXIT**] to return to the main display.

## Setting/Clearing Advisory Messages

You can read Advisory Messages left on a display telephone and clear or change an existing message.

### *To read, set, or clear an Advisory Message:*

1. Press **Function**.
2. Press **[ATT FUNCTION]**.
3. Dial the extension number.
4. Press **[SET UP MSG]**.

The display shows:

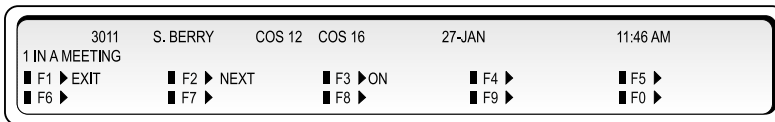

5. Do one of the following:
  - Press **[ON]** to activate the currently displayed message.
  - Press **[NEXT]** until the message you want to leave appears, and then press **[ON]** to activate the message.

If the extension has an Advisory Message active, the message will appear on the display. You can either press **[OFF]** to clear the message or replace it with another one by pressing **[NEXT]** until the replacement message appears, and then pressing **[ON]** to activate the message.

## Taking an Extension Out of Service

---

You can take an extension out of service (busy it out) if there is a problem with that extension or the system. An out-of-service extension can neither make nor receive calls.

### *To busy out an extension:*

1. Press **FUNCTION**.
2. Press [**ATT FUNCTION**].
3. Press [**STATIONS**].
4. Dial the extension number.
5. Press [**BUSY OUT**].

If the display shows "BUSY" instead of "IDLE" the extension is in use and will not be taken out of service until it becomes idle.

6. Do one of the following:
  - Press [**SET**] to busy out the extension.
  - Press [**CLEAR**] to return the extension to service.

## Call Monitoring

---

This feature allows you to monitor another extension user's phone conversation, either with or without the user's knowledge.

If your system is programmed to notify users that they are being monitored, they hear a beep when monitoring begins. Users that have a display telephone also see your name and extension number in the display for the duration of the call.

When monitoring a call, you can listen to the conversation but you can't speak to either party, and they can't hear you. However, you can join the conversation by forming a three-party conference

### A few conditions:

- The system may be programmed to disallow monitoring of any or all extensions.
- A user can only be monitored from one console or extension at a time. If you try to monitor someone who is already being monitored, you receive busy tone and BUSY appears in your display.
- If the user puts the caller on hold, transfers the call, or ends the call, you are disconnected and your monitoring session ends. Note that the system can be programmed to allow monitoring to continue while the call is on hold.
- While you are monitoring, you can't make or receive calls. Anyone who calls your telephone while you are monitoring receives busy tone. The caller can leave a callback, but is unable to camp on or override your monitoring session. If you want to place an outgoing call, you must first cancel your monitoring session.

### **To monitor a call:**

- Dial the Silent Monitoring feature access code followed by the number of the extension you wish to monitor.

If the user is on a call, INTRUDING followed by the user's extension number appears in your display.

If the user is not on the phone, you hear busy tone and the user's extension number followed by the words IS IDLE are shown in your display.

***To form a three-party conference with the user and the other party:***

- Press the **[CONF]** key.

***To end the monitoring session:***

- Press **[EXIT]**.

**Note:** *If you wish to continue monitoring after exiting the conference, you must set up the monitor again.*



---

## Chapter 5

# Using Trunk Functions





## Viewing Trunk Status

You can view trunk status information to determine the current assignment of services and features on a trunk.

### *To view the current status of an extension:*

1. Press **Function**.
2. Press [**ATT FUNCTION**].
3. Press [**TRUNKS**].
4. Enter the trunk number.
5. Press [**STATUS**] to view information about the trunk such as its Class of Service (COS) and Class of Restriction (COR).
6. Press [**EXIT**].

## Viewing Trunk Group Busy Status

You can check the status of trunk groups to see which ones are busy. A maximum of 20 groups can be displayed at one time, either when the console is idle or during call handling.

### *To check the status of trunk groups:*

1. Press **Trunk Group** to view the first 20 trunk groups.

The display shows, for example:

```

TRK GRP >      1 2 3 4 5 6 7 8 9      1 2 3 4 5 6 7 8 9      11:32 AM
STATUS >      00 ■ ■ ■ ■ ■      10 ■
■ F1 ▶EXIT    ■ F2 ▶      ■ F3 ▶      ■ F4 ▶      ■ F5 ▶
■ F6 ▶      ■ F7 ▶      ■ F8 ▶      ■ F9 ▶      ■ F0 ▶MORE...
  
```

The display tells you that trunk groups 02, 05, 07 and 12 are busy.

2. Press [**MORE...**] to display the next 20 groups.  
Repeat as required.
3. Press [**EXIT**].

## Accessing Specific Trunks

---

You can access a specific trunk and use it to make an outgoing call.

### *To access a specific trunk:*

1. Press **Function**.
2. Press **[ATT FUNCTION]**.
3. Press **[TRUNKS]**.
4. Enter the trunk number.
5. Press **[ENTER]**.
6. Press **[ATT ACCESS]**.
7. Do one of the following:
  - If the trunk is free (as indicated by dial tone), dial the outside number.
  - If the trunk is busy, either press **[FORCED RLS]** to clear the trunk of the call, or press and hold down **[OVERRIDE]** to barge into the call. Both parties will hear a long beep before you enter the conversation.

Trunks that are designated as dictation trunks (M/MM leads), and in use, cannot be accessed.

## Taking a Trunk Out of Service

---

If may be necessary to take a trunk out of service (busy it out) if there are problems with that trunk or the system. You can busy out an idle trunk or one that is in use. Afterwards, you can return the trunk to service.

### *To busy out a trunk or return a trunk to service:*

1. Press **Function**.
2. Press [**ATT FUNCTION**].
3. Press [**TRUNKS**].
4. Enter the trunk number.
5. Press [**BUSY OUT**].
6. Do one of the following:
  - Press [**SET**] to busy out the trunk.
  - Press [**CLEAR**] to return the trunk to service.



---

**Chapter 6**  
**Hotel/Motel Features**



## Displaying and Changing Room Data

Room data includes occupancy and condition status (Vacant, Clean, Outgoing Call Restrictions, etc.) and the status of message waiting, wake-up call, and other services. You can change room data while the console is idle, or when you are connected to the room.

### To display or change data for a room:

1. Press **Function**.
2. Press [**GUEST ROOM**].

The display shows:

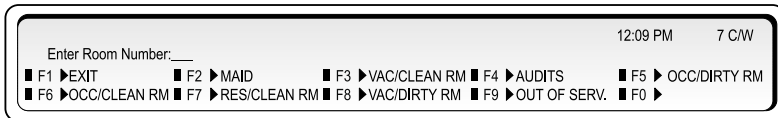

3. Dial a room number (not necessary if you're already connected to the room).

The display shows, for example:

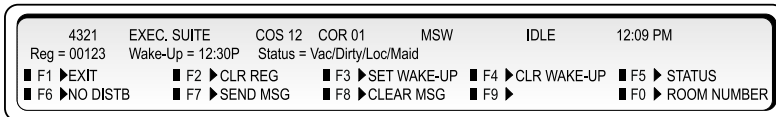

This display shows that room 4321 is vacant and dirty, the maid is in the room, and only internal calls are allowed.

4. Do any of the following:
  - Press [**CLR REG**] to clear the message register count. (See page 76.)
  - Press [**NO DISTB**] to set Do Not Disturb and block incoming calls.
  - Press [**SEND MSG**] to set or [**CLEAR MSG**] to clear the message waiting indicator on the room phone.
  - Press [**SET WAKE-UP**] to set or [**CLR WAKE-UP**] to clear a wake-up call time. (See page 74.)
  - Press [**STATUS**] to change the room's Occupany or Condition status (See *Changing Room Occupancy and Condition Status* on page 73.)
  - Press [**ROOM NUMBER**] to display the status of another room. (This option is not available when the console is connected to a room.)

## Listing/Counting Rooms by Occupancy and Condition Status

You can display a list of rooms by occupancy and condition status—for example, Vacant and Not Clean, or Occupied and Maid Present. The system also reports the total number of rooms that are in the state you specify. You can cycle through all rooms or start with a particular room number—for instance, the first room on the third floor.

### To list all rooms by occupancy and condition status:

1. Press **Function**.
2. Press **[GUEST ROOM]**.

The display shows:

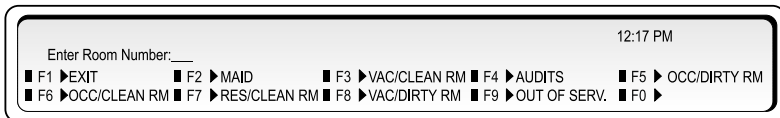

3. Press the softkey that corresponds to the rooms you want to display—for example, to display all vacant and clean rooms, press **[VAC/CLEAN RM]**.

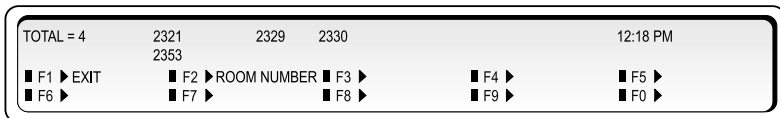

4. Press **[MORE...]** to display the next 10 rooms matching the specified states.

If a printer is attached to the console, you can print a list of all vacant or occupied rooms. For more information, see *Printing Reports* on page 77.

### To display a list of rooms beginning with a particular room number:

1. Complete steps 1 to 4 above.
2. Press **[ROOM NUMBER]**.
3. Dial the number of the first of the rooms you want to display.



## Changing Room Occupancy and Condition Status

You can change the occupancy and condition status of a room while the console is idle or while you are connected to the room.

The occupancy and condition states are as follows:

Occupancy	Condition
Vacant	Clean
Occupied	Dirty
Reserved	Maid
Guaranteed	To Inspect
	Out of Service

### *To change a room's occupancy and condition status:*

1. Press **FUNCTION**.
2. Press **[GUEST ROOM]**.
3. Dial the room number (not necessary if you are already connected to the room).
4. Press **[STATUS]**.
5. Press the softkey that corresponds to the states you want to set—for example, to change a room from vacant to occupied press **[OCCUPIED]**.



**Note:** The Maid status can only be changed from the room by dialing a code.

Your system may be programmed to automatically change all “occupied and clean” rooms to “occupied and dirty” at a set time. Ask your communications department for information.

## Setting/Canceling Wake-up Calls

Both you and the guest can set, change, and cancel wake-up calls for a guest room. The system does not distinguish whether a wake-up call is set, changed, or canceled from the attendant console or guest room telephone. So, for example, a guest can cancel a wake-up call that you set and vice versa.

You can set or cancel a wake-up call while the console is idle or while connected to the guest room.

If a printer is attached to the console, a report may print each time you set, change, or cancel a wake-up call.

### *To set or cancel a wake-up time while connected to the guest room:*

1. Press **[SET WAKE-UP]**.
2. Enter the time using four digits (hh:mm).  
For example, for 6:30 enter 0630.
3. Do one of the following:
  - Press **[SET]** to set the time as AM.
  - Press **[PM]** to set the time as PM. (**[PM]** only appears if the system clock is set to 12-hour format, and the hour entered is in the range 01 – 12.)

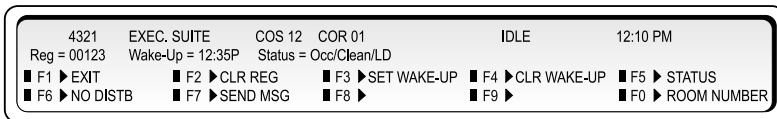

### *To set or change a wake-up time when NOT connected to the guest room:*

1. Press **Function**.
2. Press **[GUEST ROOM]**.
3. Dial the room number.
4. Follow steps 1-3 from the previous procedure.

### *To cancel a wake-up call:*

1. Press **Function**.
2. Press [**GUEST ROOM**].
3. Dial the room number.
4. Press [**CLR WAKE-UP**].
5. Press [**EXIT**].



**Note:** Some display sets can set their own timed reminder. The above procedures will also clear or change a reminder already set by the user.

If the guest fails to answer the wake-up call, the system will ring the room twice more at five-minute intervals. If a third wake-up call goes unanswered or reaches a busy line, the system may generate a minor alarm at the console.

## Setting Room Call Restrictions

---

You can restrict guests from placing local or long distance calls from their room phones. The procedure you use to set call restrictions depends on whether the hotel/motel is using a Property Management System.

### *If the hotel/motel is NOT using a Property Management System*

1. Press **Function**.
2. Press [**GUEST ROOM**].
3. Dial the room number.
4. Press [**STATUS**].
5. Do one of the following:
  - Press [**INTERNAL**] to allow internal calls only.
  - Press [**LOCAL**] to allow internal and local calls.
  - Press [**LONG DIST**] to allow internal, local, and long distance calls.

### *If the hotel/motel is using a Property Management System*

1. Press **Function**.
2. Press [**GUEST ROOM**].
3. Dial the room number.
4. Press [**RESTRICT O/G**].

The phone is restricted from making outgoing trunk calls. To remove the restriction and allow outgoing calls, repeat the procedure.

## Blocking Room-to-Room Calls

---

You can use the **Block** key on the console to bar calls between guest rooms. Only room phones programmed with call blocking will be affected by this; ask your communications department for further information.

### *To block room-to-room calls:*

- Press **Block**.

The lamp above the **Block** key lights and stays lit until blocking is canceled.

## Displaying/Clearing a Message Register

---

The message register is a record of all external calls placed from a guest room telephone. You can display and clear a room's message register while the console is idle or while connected to the guest room.

### *To display or clear a room's message register:*

1. Press **Function**.
2. Press [**GUEST ROOM**].
3. Dial the room number (not necessary if you are already connected to the room).
4. Press [**CLR REG**].

If a printer is attached to the console, a report may print showing the contents of the register before it was cleared.

## Printing Reports

If a printer is connected to the console, you can request printed reports (audits) of message registers, room status and automatic wake-ups.

Each audit has its own format and some are printed automatically. For example, when a wake-up call is set, changed or canceled, the printer automatically records it.

### *To print a report:*

1. Press **Function**.
2. Press [**GUEST ROOM**].
3. Press [**AUDITS**].

The display shows:

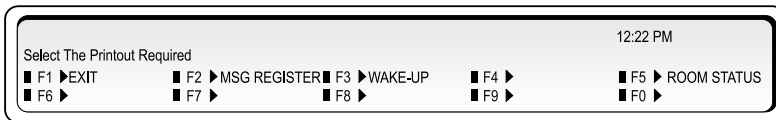

4. Select the report you want to print.
5. Press [**EXIT**].



---

## Chapter 7

# Reference





## Telephone Directory

---

Name	Number
POLICE:	
FIRE:	
HOSPITAL:	
TROUBLE WITH EXTENSION OR CONSOLE:	



## Class of Service/Restriction

Each extension and trunk has a COS (Class of Service) and a COR (Class of Restriction) that defines what the user of that extension or trunk can or cannot do. The system can have up to 50 of each, although most companies use only a few.

To help you answer questions from users who may be having problems with the system, you may want to record a brief description of the most common COSs and CORs. For example, COS 1 might mean, "Allows only local calls," and COR 10 might be, "No long distance calls after 6 PM." Your communications department can give you the required details.

COS	COS NAME	ALLOWS...

COR	COR NAME	RESTRICTS...

## Console Display Abbreviations

Abb.	Meaning
ABBR	Abbreviated
ACC	Account
ANSR	Answer
ATT	Attendant
BSY OUT	Busied Out
CAN	Cancel
CBK	Callback
CDE	Customer Data Entry
CLR	Clear
COR	Class of Restriction
COS	Class of Service
C/W	Call Waiting
DD/MM/YY	Day/month/year
DISA	Direct Inward System Access
DISTB	Disturb
DND	Do Not Disturb
DST	Destination

Abb.	Meaning
FLEX	Flexible
FWD	Forwarding
IDENT	Identity
INT	Intercept/Internal
LD	Long Distance
LDN	Listed Directory Number
LOC	Local
MSG	Message
MSW	Message Waiting
OCC	Occupied
RCL	Recall
REG	Register
RLS	Release
RM	Room
RS	Room Status or Restricted Outgoing Calls
SER	Serial
VAC	Vacant

## Advisory Messages for Display Telephones

The following default messages can appear on telephones equipped with displays.

Message Number	Message
01	IN MEETING
02	OUT OF TOWN
03	ON VACATION
04	OUT ON A CALL
05	OUT TO LUNCH
06	GONE FOR THE DAY
07	GONE HOME
08	IN TOMORROW
09	
10	
11	
12	
13	
14	
15	

Authorized users can change these messages and program seven more for system-wide use. Keep a record of any changes and additions.

For instructions on setting these messages from the console, see page 58.

## Glossary

---

### Busy out

A feature allowing you to make a line or equipment indicate busy to an incoming call. In effect, you take the line out of service until it can be repaired or tested.

### Camp-on

A feature allowing the system to queue calls directed to a busy extension, and then automatically connect the waiting party when the extension becomes free. The busy extension hears a quick beep to indicate a call is waiting.

### Central Office (CO)

A facility housing the public telephone system and related equipment which provides telephone service for customers in a geographical area.

### Class of Restriction (COR)

When the system is programmed, the extensions and trunks are assigned to different Classes of Restriction. A COR controls the outgoing call capabilities of the extension or trunk. For example, an extension can be assigned a COR that prevents it from making outside calls other than with the assistance of the operator.

### Class of Service (COS)

When your telephone system is programmed, the extensions are assigned to different Classes of Service. Each class has access to a specific set of features.

### DISA (Direct Inward System Access)

A feature which allows callers to dial directly into the telephone system and use its features and facilities.

### Hardware

The physical components of the system.

## Hunt Group

Extensions assigned to a group with a common (pilot) telephone number as well as their own personal extension numbers. An incoming call to a hunt group will ring the first available extension.

## LDN Keys (Listed Directory Number)

Call-handling keys which allow you to select the sequence in which you answer calls from outside the PABX.

## Macro

A macro is a series of keystrokes that you assign to a single key. Instead of repeating the keystrokes each time you want to perform a task, you can press the macro key to execute all the keystrokes at once.

## PABX (Private Automatic Branch Exchange)

Telephone switching system for private use by a company.

## Recall

A call which returns to the console after being transferred to a busy or unanswered extension.

## Software

The routines, programs, and instructions required to run the system.

## Trunk

A trunk (outside line) is the external communications link between two switching systems. This link can be between one or more telephone systems (PABXs) or the PABX and Central Office equipment.

## Tone Demonstration

Your telephone system has several tones to inform you of the progress of your call. You can use the Tone Demonstration feature to familiarize yourself with the tones.

1. Dial the Tone Demonstration access code \_\_\_\_\_.  
(Ask your communications department for the code.)
2. Dial a two-digit tone code from the list below.
3. Continue dialing codes to listen to other tones.
4. Hang up when you are finished.

Code	Tone Name	Meaning
11	Dial Tone	Heard when you lift the handset.
12	Transfer Tone	Heard at an extension when the user places a call on hold to consult with another party or to transfer the call.
13	Busy Tone	Heard when the number you dialed is busy.
14	Special Busy Tone	Heard when the extension you called has Do Not Disturb activated.
15	Ringback Tone	Heard when the destination you dialed is ringing.
16	Not used	
17	Reorder Tone (Error Tone)	Heard when a feature is not available to you or not in your Class of Service, or when you dial an invalid number.
18	Conference	Heard when a new person joins a conference call.
19	Call Waiting Tone (Camp-on)	Heard during a conversation when you have an internal call waiting to be answered.
20	Intrusion Tone (Override)	Heard by all parties in a conversation when someone overrides (intrudes into) a call.
21	Interrupted Dial Tone	Heard when you lift the handset at an extension that has Do Not Disturb or Call Forward Always activated.
22	Not used	
23	Waiting on Hold Tone	Heard by a caller on hold and during camp-on.
24	Paging Tone	Heard when you are connected to the loudspeaker paging equipment.



Code	Tone Name	Meaning
25	Not used	
26	Trunk Camp-on Double Beep Tone	Heard during a conversation when you have an external call waiting.
27	ARS Expensive Warning Tone	If your system has Automatic Route Selection (ARS), you will hear this tone when no inexpensive routes are available for your long-distance call. The tone is a warning that your call is taking an expensive route.
28	ARS Dial Tone	If your system has Automatic Route Selection (ARS), you will hear this tone after you dial the trunk access code.
29	Override Warning Tone	Heard by all parties in a conversation when someone overrides (intrudes into) the call.
30	Privacy Release Tone	Heard when privacy is released on a telephone and the new member joins the call.
31	Auto Answer Call End Tone	Heard by a user that has a telephone in Auto-Answer mode when the calling party hangs up.
32	Attendant Error Tone	Heard by the Attendant, when attempting to do something that is not allowed, such as trying to connect two devices that are not allowed to be connected.
33	Ringer Pitch Adjustment	Dialed at telephones to hear adjustments to ringer pitch.



# Index

## Numerics

911 call alarms, viewing and clearing, 46

## A

Abbreviated Dialing numbers, entering and viewing, 49

abbreviations, console display, 84

accessing individual trunks, 66

Advisory Messages

calling extensions with Advisory Messages 28

list of Advisory Messages, 85

setting and clearing on extensions, 58

alarms, viewing and clearing, 45

All Set Page, 33

Answer key, 12, 25

answering calls

multiple calls waiting, 26

new call indication, 26

new calls, 25

when Night Service enabled, 38

applications, accessing, 51

audits (printouts) for guest rooms, 77

## B

bell, *See* ringer

Block key, 12

blocking calls between guest rooms, 76

busy

recalls, 31

transferring to busy extensions, 27

busy out

definition, 86

extensions, 59

trunks, 67

## C

cables, console, 10

Call Block, 76

call forwarding

cancel on all extensions, 48

setting and cancelling on individual extensions, 55

call logging 40

Call Monitoring 60

call parking 39

call restrictions for guest rooms, 75

call splitting, 30

Callback

about, 27

canceling on all extensions, 48

leaving at an extension, 27

Camp-on, definition, 86

Cancel key, 12

canceling

Advisory Messages, 58

all Call Forwarding, 48

all callbacks, 48

Call Forwarding on individual extensions, 55

Do Not Disturb on individual extensions, 35, 56

Message Waiting on individual extensions, 35, 56

CAS, *See* Centralized Attendant Service

CDE (Customer Data Entry), 51

Central Office, definition, 86

Centralized Attendant Service, 42

Class of Restriction, definition, 86

Class of Service, definition, 86

conferences, setting up, 30

console

cables, 10

components, 10

directory number, displaying, 51

display abbreviations, 84

display, 13

handset/headset jacks, 10

intercepts, 32

keys, 11

language, changing, 17

lockout, 17

Night/Day Service, switching, 16

ringer, adjusting, 16

ringer, turning on/off, 16

Cursor control keys, 11

Customer Data Entry, 51

## D

date, setting, 47

Day Service, switching, 16  
 Dial pad keys, about, 11  
 dialing mistakes, correcting, 27  
 Directed Call Pickup, 38  
 directory number, display console, 51  
 DISA  
     access codes, changing, 48  
     definition, 86  
 display  
     abbreviations, 84  
     about the console, 13  
     changing language, 17  
     language, changing, 13  
 DND  
     overriding, 27, 36  
     setting and canceling on an extension, 35, 56  
 Do Not Disturb, *See* DND  
 Door Opener 42

**E**  
 emergency 911 call alarms, viewing and clearing, 46  
 extending calls, *See* transferring calls  
 external calls, allowing/restricting from guest rooms, 75

**F**  
 Fixed function keys, 12  
 flashing on trunks, 38  
 Flexible Night Answer, 50  
 French, console language, 17  
 Function key, 12

**G**  
 Group Paging, 33  
 Guest Room  
     blocking room-to-room calls, 76  
     calling restrictions, 75  
     changing occupancy and condition status, 73  
     displaying and clearing Message Register, 76  
     listing rooms by occupancy and condition status, 72  
     printing status, 77  
     wake-up calls, 74

**H**  
 hardware, definition, 86  
 Hold  
     Hold 4+ key, 29  
     keys, 12  
     pickup, 29  
     placing calls on, 28  
     recall, 29  
     retrieving calls on hold, 28  
     stacked, 30  
 Hunt Group, definition, 87

**I**  
 identity  
     console, 51  
     system, 50  
 intercepts to console, 32  
 intercom calls 34  
 internal calls, allowing/restricting from guest rooms, 75

**J**  
 jacks, handset/headset, 10

**L**  
 language, changing on display, 17  
 last number redial, 36  
 LDN (Listed Directory Number), definition, 87  
 local calls, allowing/restricting from guest rooms, 75  
 lockout console, 17  
 long distance calls, allowing/restricting from guest rooms, 75

**M**  
 macros, programming 18  
 making calls, 28  
 Message Register  
     displaying and clearing, 76  
     printing, 77  
 Message Waiting  
     reading messages, 57  
     setting and canceling on an extension, 35, 56  
 misdialled numbers, correcting, 27

multiple console operation, 41

## N

new call indication, 26

New Call Ringer 15

night answering points, setting up, 50

Night Service

answering calls when Night

Service enabled, 38

setting up answering points, 50

switching, 16

no answer recalls, 31

## O

outgoing calls, allowing/restricting

from guest rooms, 75

override busy and Do Not Disturb, 36

## P

PABX, definition, 87

Page key, 12

paging, 32

picking up calls on hold at the

console, 29

placing calls, 28

printing guest room reports, 77

## R

recalls

answering, 31

definition, 87

redialing, last number redial, 36

Release key, 12

restricting calls from guest rooms, 75

ringer

adjusting volume, 16

New Call 15

new call 15

output 15

turning on/off, 16

Ringer Volume keys, 11

room status

changing, 73

listing by occupancy and condition

status, 72

## S

Serial Call, 37

service

switching to Day/Night, 16

taking extensions in or out, 59

taking trunks in or out, 67

Set Page key, 12

Set Paging, 33

software version, displaying, 51

software, definition, 87

Spanish, console language, 17

splitting conferences, 30

stacked hold, 30

SUPERSET PKM48, using 22

system

alarms, viewing and clearing, 45

identification, displaying and

changing, 50

software version, displaying, 51

time and date, setting, 47

System Speed Calling numbers, See

Abbreviated Dialing numbers

## T

time, setting, 47

tone demonstration, 88

Tone Signaling

enabling/disabling tones, 37

voice mail, 42

transferring calls, 26, 41

Trunk Group key, 12

trunks

accessing individual, 66

busy out, 67

definition, 87

flashing, 38

viewing status of individual trunks,  
65

viewing status of trunk groups, 65

## V

voice mail, affect on console

operations, 42

volume, handset/headset, 16

## W

wake-up calls

printing, 77

setting and canceling, 74

